



MERLIN STEALTH — Electric Fence Energizer

INSTALLERS MANUAL

Revision 1.5
23 February 2007

MERLIN STEALTH: INSTALLERS MANUAL Table of Contents

INTRODUCTION.....	3
INSTALLER OPTIONS.....	4-11
ALARM SETTING EXAMPLES.....	12
MOUNTING / BATTERY REPLACEMENT DRAWING	13
LOW VOLTAGE WIRING DIAGRAM	14
HIGH VOLTAGE WIRING DIAGRAM M15S & M18S.....	15
HIGH VOLTAGE WIRING DIAGRAM M25S & M28S.....	16
PC BOARD LAYOUT & SERVICE CONDITIONS DIAGRAM.....	17
PC BOARD REPLACEMENT PROCEDURES.....	18
INSTALLER NOTES.....	19-23
DOCUMENT REVISION HISTORY.....	24

INTRODUCTION

The Merlin Stealth Range of Energizers is functionally very similar to the previous generation of Merlin energizers.

It is recommended that a suitable training course is attended before altering the functionality of the energizer. Ensure that municipal by-laws are adhered to.

The Merlin Stealth Range includes earth-loop monitoring and has an RS232 port for diagnostics and connectivity. The embedded software incorporated in the unit may be revised from time to time. For the latest features or revisions please visit our web site at: www.nemtek.com

To load factory default settings: Unplug the energizer from the mains and disconnect one of the battery terminals. Reconnect the battery terminal and apply mains to the energizer. Within 65 seconds of reconnecting the battery terminal, the key sequence 2 3 8 9 # must be entered on the keypad. In each of the appropriate tables the shaded row indicates the factory default setting.

The Merlin Stealth Energizer™ may be networked. This can be done for either multiple energizer synchronization or for controlling and monitoring a large number of energizers. An advanced installers course is compulsory for installers wanting to access these features.

Electric fencing can be lethal. Please inform the user to avoid head contact with the fence. Explain to the user the options of current limiting resistors and the low-voltage operation of the energizer.

DANGER:

DO NOT PRESS THE SWITCH (WITH THE SPRING ATTACHED) WITH THE LID OPEN!

DO NOT MODIFY OR ALTER THE UNIT

ENTER PROGRAMMING MODE



Before any of the installer options can be changed, the unit must be in programming mode. To do so, enter the 6 digit installer PIN followed by the * 0 # keys.

- The keypad will beep seven times if the PIN was correct. The unit is now in programming mode.
- If no key is pressed for four minutes, the system will automatically exit the programming mode. It is better to press the *# key sequence to exit the programming mode.
- The default installer PIN is **0 1 2 3 4 5**

EXIT PROGRAMMING MODE

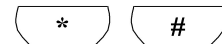

When finished it is important to exit the programming mode. While in programming mode, you will be unable to access any user functions from the keypad. Exit from programming mode is acknowledged by seven beeps.

CHANGE INSTALLER PIN



The default installer PIN can be changed by pressing the 0 key twice, followed by the new PIN and the # key. The keypad will beep six times if the pin was accepted.

- The new PIN must be 6 digits long.
- If you cannot remember the PIN, default the unit and use **0 1 2 3 4 5** as the PIN.

Note. On changing a parameter the keypad will beep in response.

- 1 beep: fence associated parameter.
- 2 beeps: gate related parameter.
- 3 beeps: alarm timing parameter/gate2 input function etc.
- 4 beeps: battery related.

SIREN-ON TIME

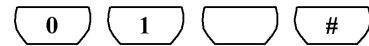

The time that the siren will be on for, can be changed by pressing the **0** key, followed by the **1** key. Select the desired time from the table and press the corresponding number from **0** to **9** followed by the **#** key. The keypad will beep three times to indicate that the new setting was accepted.

Example: To change the Siren-On Time to 4 minutes, enter **0 1 8 #**

0	2 Sec
1	5 Sec
2	10 Sec
3	30 Sec
4	45 Sec
5	1 Min
6	2 Min
7	3 Min
8	4 Min
9	4 min 30 sec

ALARM-OFF TIME

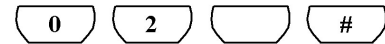

The time for all alarm events to be ignored after the Siren-On Time has elapsed, can be changed by pressing the **0** key followed by the **2** key. Select the desired time from the table and press the corresponding number from **0** to **9** followed by the **#** key. The keypad will beep three times to indicate that the new setting was accepted.

Example: To change the Siren-Off Time to 2 minutes, enter **0 2 6 #**

0	2 Sec
1	5 Sec
2	10 Sec
3	30 Sec
4	45 Sec
5	1 Min
6	2 Min
7	3 Min
8	4 Min
9	4 min 30 sec

NUMBER OF ALARM EVENTS BEFORE RE-ARM

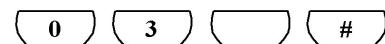

The number of alarm events that are allowed before the RE-ARM timer becomes active. This can be changed by pressing the **0** key, followed by the **3** key. Select the desired number of times from the table and press the corresponding number from **0** to **9** followed by the **#** key. The keypad will beep three times to indicate that the new setting was accepted.

Example: To change the Number of Events allowed to 8, enter **0 3 7 #**

0	1 Event
1	2 Events
2	3 Events
3	4 Events
4	5 Events
5	6 Events
6	7 Events
7	8 Events
8	9 Events
9	16 Events

ALARM RE-ARM TIME



The alarm annunciation process may be repeated after a re-arm period. The re-arm time for the system can be changed by pressing the **2** key, followed by the **0** key. Select the desired re-arm time from the table and press the corresponding number from **0** to **9** followed by the **#** key. The keypad will beep three times to indicate that the new setting was accepted. Do not alter without understanding the ramifications! On turning the system OFF and On again manually all alarm timers and counters are reset. Please see attached **ALARM SETTING EXAMPLES**.

Example: To change the re-arm time to 4 days, enter **2 0 6 #**

0	20 Sec
1	6 Hr
2	12 Hr
3	24 Hr
4	2 Days
5	3 Days
6	4 Days
7	5 Days
8	6 Days
9	7.7 Days

GATE 1 DELAY TIME

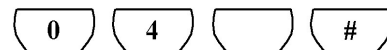

The time delay for the gate to stay open before the alarm is activated, can be changed by pressing the **0** key, followed by the **4** key. Select the desired time delay from the table and press the corresponding number from **0** to **9** followed by the **#** key. The keypad will beep twice to indicate that the new setting was accepted.

Example: To change the Gate Delay Time to 1 Minute, enter **0 4 5 #**

0	2 Sec
1	5 Sec
2	10 Sec
3	30 Sec
4	45 Sec
5	1 Min
6	2 Min
7	3 Min
8	4 Min
9	4 Min 30 Sec

GATE 2 DELAY TIME

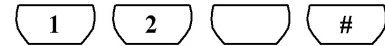

The time delay for the gate to stay open before the alarm is activated, can be changed by pressing the **1** key, followed by the **2** key. Select the desired time delay from the table and press the corresponding number from **0 to 9** followed by the **#** key. The keypad will beep twice to indicate that the new setting was accepted.

Example: To change the Gate Delay Time to 4 minutes, enter 1 2 8 #

0	2 Sec
1	5 Sec
2	10 Sec
3	30 Sec
4	45 Sec
5	1 Min
6	2 Min
7	3 Min
8	4 Min
9	4 Min 30 Sec

HIGH POWER FENCE VOLTAGE

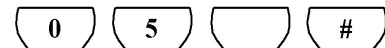

The open circuit fence voltage can be changed by pressing the **0** key, followed by the **5** key. Select the desired voltage from the table and press the corresponding number from **0 to 9** followed by the **#** key. The keypad will beep once to indicate that the setting was accepted.

Example: To change open circuit Fence Voltage to 6kV6 on a M15, enter **0 5 2 #**

M15 & M25
Typical readings

	V peak open circuit. Volts	V peak 500 ohm load	Energy (500 ohm load) J
0	6000	3900	2.50
1	6300	4150	2.80
2	6600	4300	3.00
3	7100	4500	3.20
4	7500	4850	3.70
5	7750	5050	4.00
6	7900	5200	4.20
7	8100	5300	4.40
8	8300	5450	4.60
9	8500	5600	4.80

M18 & M28
Typical readings

	V peak open circuit. Volts	V peak 500 ohm load	Energy (500 ohm load) J
0	8000 auto	7100	6.8
1	7000	4500	3.20
2	7700	4950	3.70
3	8200	5300	4.20
4	8500	5650	4.80
5	8900	5950	5.20
6	9200	6850	6.40
7	9300	7100	6.80
8	9300	7350	7.30
9	9300	7600	7.60

LOW POWER FENCE VOLTAGE



The open circuit low power fence voltage can be changed by pressing the **0** key, followed by the **6** key. Select the desired voltage from the table and press the corresponding number from **0** to **9** followed by the **#** key. The keypad will beep once to indicate that the new setting was accepted.

Example: To change the open circuit Low Power Fence Voltage to 1450 Volts, enter **0 6 3#**

Typical readings

	V peak open circuit Volts	V peak 500 ohm	Energy (500 ohm load) J
0	1250	775	0.11
1	1350	825	0.12
2	1400	900	0.14
3	1450	950	0.16
4	1550	975	0.17
5	1650	1000	0.18
6	1700	1050	0.21
7	1750	1100	0.22
8	1850	1150	0.24
9	1900	1200	0.26

FENCE ALARM VOLTAGE (HV Mode)

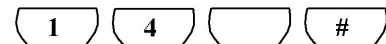

The fence alarm voltage (in HV mode) can be changed by pressing the **1** key, followed by the **4** key. Select the desired voltage from the table and press the corresponding number from **0** to **9** followed by the **#** key. The keypad will beep once to indicate that the new setting was accepted.

	Approx. Fence Alarm Voltage (kV)	Approx. Fence Check Voltage (kV)*
0	1	2.3
1	1.2	2.7
2	1.7	3.0
3	2.0	3.2
4	2.3	3.7
5	2.5	4.3
6	2.7	4.8
7	2.8	5.4
8	3.1	5.8
9	3.2	6.0

*M28 and M25 use different check voltages.

STROBE LIGHT FUNCTION

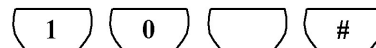

The strobe light outputs can be used for alarm indication or fence On/Off (Zone 1) and high/low voltage (Zone 2) indication. This can be changed by pressing the **1** key followed by the **0** key. Select the desired function from the table and press the corresponding number from **0** or **1** followed by the **#** key. The keypad will beep three times to indicate that the new setting was accepted.

Example: To change the Strobe Light Function so that the strobe light switches on whenever the fence is on, enter 1 0 1 #

0	Strobe light = Alarm
1	Strobe light = fence ON

The default Strobe Light Function is option 0, the strobe light output indicating an alarm condition.

MAGNETIC SWITCH FUNCTION

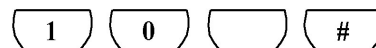

The magnetic switch may be disabled if a keypad or remote On/Off switch is used. This can be changed by pressing the **1** key followed by the **0** key followed by the desired 2 or 3.

Example: To disable the magnetic switch enter 1 0 2 #

2	Magnetic Switch disabled
3	Magnetic Switch enabled

By default the magnetic switch is functional.

KEYPAD DETECT FUNCTION (NOT AVAILABLE)

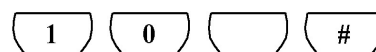

The energizer can be configured to detect if one or more keypads is present. The keypad detect function can be altered by pressing the 1 key, followed by the 0 key. Select the desired state from the table and press the corresponding number from 6 to 7 followed by the # key. The keypad will beep twice to indicate that the new setting was accepted.

Example: To enable the keypad detect function, enter **1 0 6 #** (detection period is 15 seconds)

6	Keypad detect on
7	Keypad detect off

By default the Keypad detect is **off**.

FENCE VOLTAGE CONTROL



The energizer can be configured to change between High and Low voltage modes depending on the Gate2 input. The fence voltage control can be altered by pressing the **1** key, followed by the **3** key. Select the desired function from the table and press the corresponding number from **0** or **1** followed by the **#** key. The keypad will beep three to indicate that the new setting was accepted.

Example: To enable the fence voltage control via Gate 2 input, enter **1 3 0 #**

0	Fence Voltage Control
1	Gate Function

BATTERY SERVICE LEVEL NORMAL OPERATION

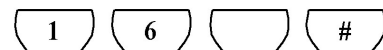

During normal operation the battery level is monitored and may result in a service indication. The sensitivity or level at which the service level indication is given may be adjusted by the installer. The battery service level for the system can be changed by pressing the **1** key, followed by the **6** key. Select the desired level time from the table and press the corresponding number from **0** to **9** followed by the **#** key. The keypad will beep three times to indicate that the new setting was accepted. Do not alter without understanding the ramifications!

Note. The unit will protect the battery by disconnecting it from the Energizer as soon as the voltage drops below a factory set level. The Installer has no control over this protection.

0	10.5 Volts
1	10.8 Volts
2	11.1 Volts
3	11.4Volts
4	11.7Volts
5	12.0Volts
6	12.3Volts
7	12.6Volts
8	12.9Volts
9	13.2Volts

BATTERY AUTO-CHECK ENABLE AND LEVEL

[1] [7] [] [#]

The energizer may be configured to do an automatic battery check at regular intervals. The mains is disabled for 20 minutes (there is no visible indication of this unless the diagnostics port is used) and the battery voltage monitored. Should the battery voltage fall below the acceptable level a service indication will result. The auto-check voltage for the system can be changed by pressing the **1** key, followed by the **7** key. Select the desired check voltage from the table and press the corresponding number from **1** to **9** followed by the **#** key. The keypad will beep three times to indicate that the new setting was accepted. Do not alter without understanding the ramifications! Keying in a **0** disables this function.

0	No auto-check
1	10.5Volts
2	10.8Volts
3	11.1Volts
4	11.4Volts
5	11.7Volts
6	11.8Volts
7	11.9Volts
8	12.0Volts
9	12.1Volts

BATTERY AUTO-CHECK REPEAT INTERVAL

[1] [8] [] [#]

The repeat interval for the battery auto-check can be changed by pressing the **1** key, followed by the **8** key. Select the desired interval from the table and press the corresponding number from **0** to **9** followed by the **#** key. The keypad will beep three times to indicate that the new setting was accepted. Do not alter without understanding the ramifications! Note that on loading factory default values the battery will not be tested for the first week irrespective of the interval that has been set.

0	6 Hr
1	12 Hr
2	24 Hr
3	2 Days
4	3 Days
5	4 Days
6	5 Days
7	6 Days
8	7 Days
9	7.7 Days

LID ALARM FUNCTION

3 0 0 #

With the code 300# the energizer can be programmed to give a tamper alarm when the front lid is removed while the energizer is operating. In default condition no alarm is given.

Once the function is programmed it is stored in memory and if the function is not required anymore it can be programmed out with the same 300# code.

Check after programming that the function operates as required.

REMOTE ON/OFF ABSOLUTE OR TRANSITION SENSITIVE

3 0 1 #

In the default condition the energizer will change its on/off state every time when the remote on/off input is opened or closed.

The energizer can be programmed with the code 301# so that the energizer will always switch on when the remote input is opened and always switch off when the input is closed.

Once programmed the function can be changed back in programming mode to the default condition with the same 301# code.

Check after programming that the function operates as required.

ALARM SETTING EXAMPLES

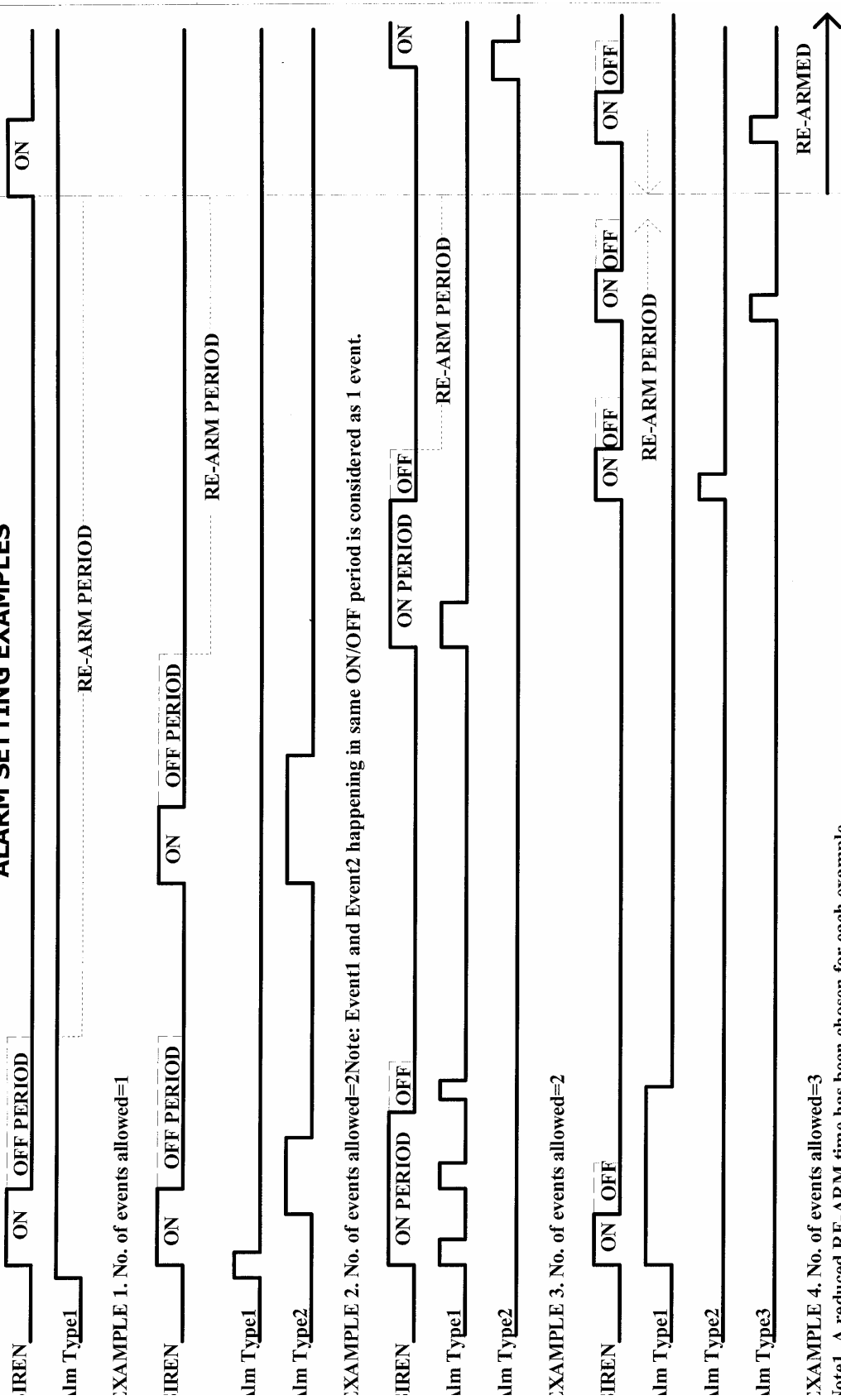

EXAMPLE 1. No. of events allowed=1
 EXAMPLE 2. No. of events allowed=2 Note: Event1 and Event2 happening in same ON/OFF period is considered as 1 event.
 EXAMPLE 3. No. of events allowed=2
 EXAMPLE 4. No. of events allowed=3
 Note1. A reduced RE-ARM time has been chosen for each example.
 2. The OFF PERIOD is the period where all events are ignored.

*Energizer to be mounted vertically against a flat surface, in well ventilated area.

*Avoid prolonged exposure to direct sunlight

STEP 1: Disconnect mains. Open the lid by removing the two cap screws. Unplug the battery terminals if connected.

STEP 2: Remove screws and battery bracket

STEP 3: Remove battery

*Dispose of old battery according to legal requirements.

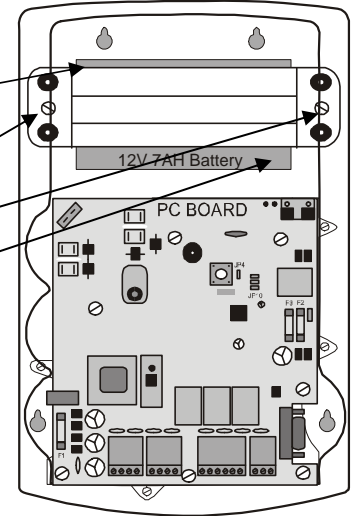

STEP 4: Drill 4 x 8mm holes for mounting the unit. Four nail-in anchors are supplied with the unit. Insert the plastic sleeve of the nail-in anchor from the inside of the box and then hammer the screw in with a screw driver and hammer.

NB: Always insert the plastic sleeve from the inside of the box.

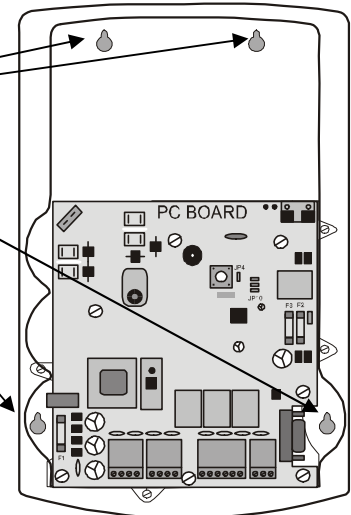

STEP 5: Connect the Black battery lead to the negative terminal of the battery.

Insert battery with the positive terminal to the top.

STEP 6: Place the battery bracket back and fasten the screws.

STEP 7: Connect the Red battery lead to the positive terminal of the battery.

Close the lid by hooking the top of the lid in first and then fasten the bottom down with the two cap screws. Apply mains to the unit.

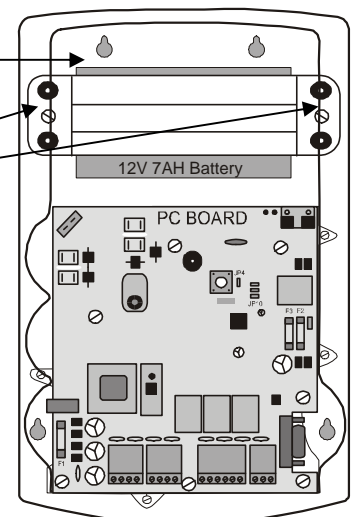

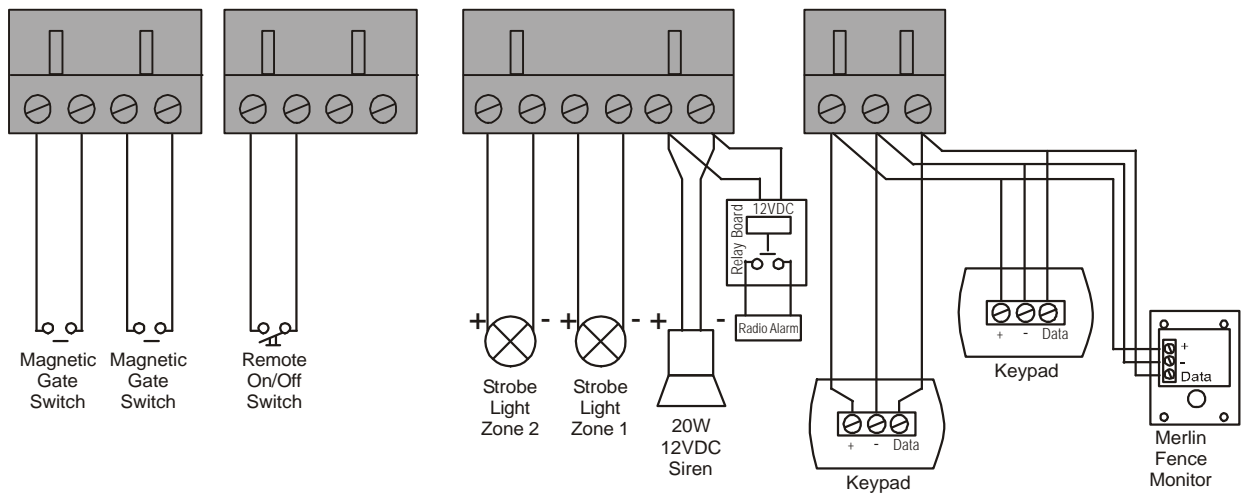
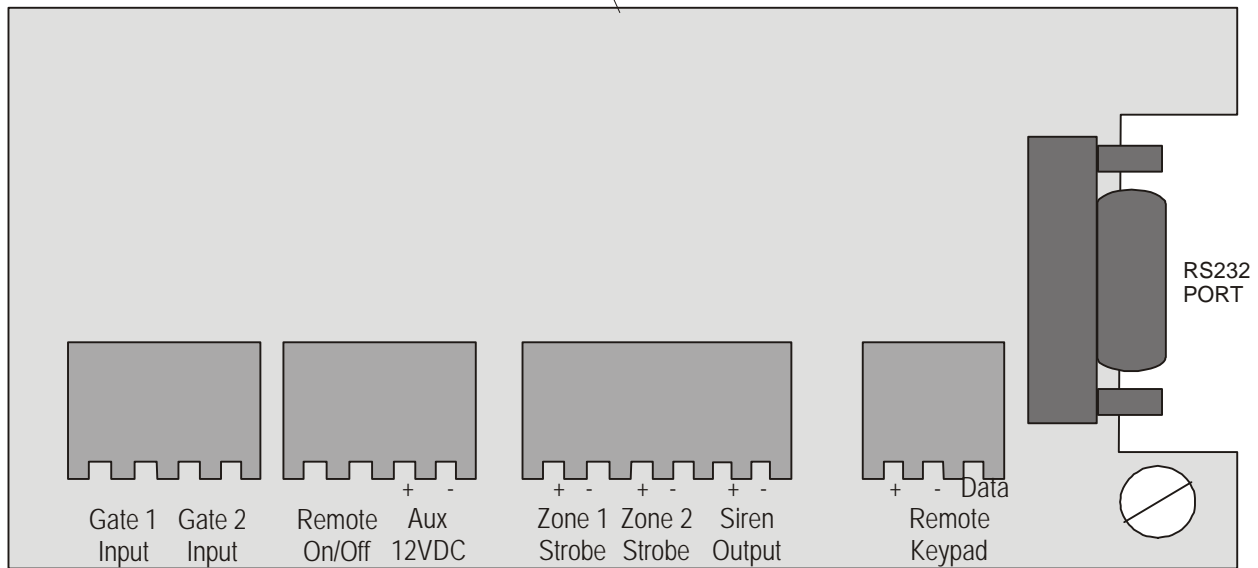
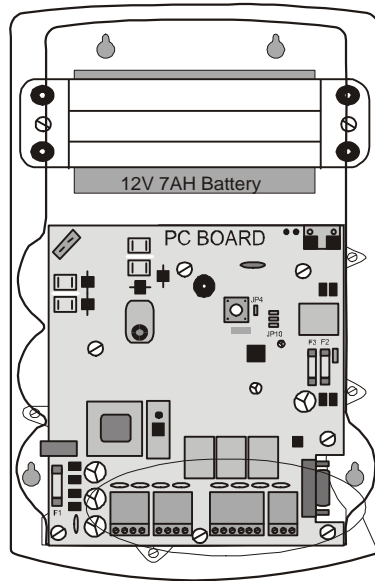

LIVE WIRE CONNECTION

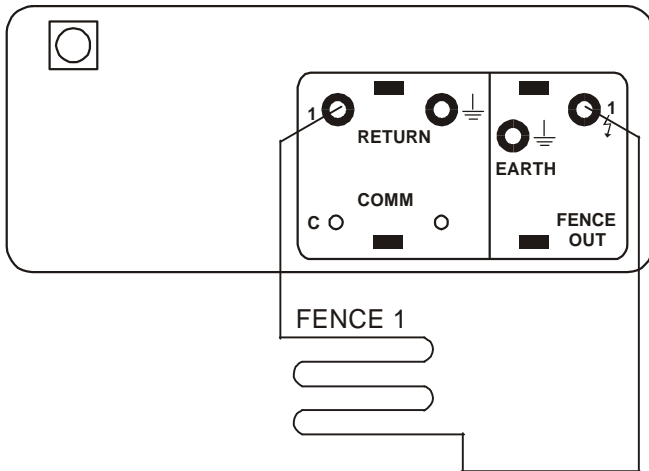

NOTE:

The installation and erection of the electric fence to be done in South Africa according to SANS 10222-3 latest edition. In other countries according to the local specifications.

EARTH WIRE CONNECTION WITH EARTH LOOP MONITORING

Preferred connection method

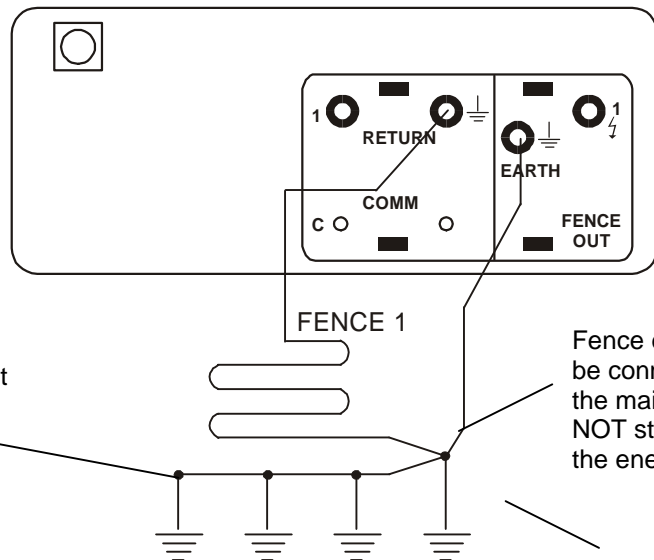

The earth spikes are connected to one wire of the fence and the wire is only coupled to the other fence earth wires at the main earth spike

Fence earth wire to be connected from the main earth spike NOT straight from the energizer

Main earth spike – install close to the energizer

EARTH WIRE CONNECTION WITHOUT EARTH LOOP MONITORING

Alternative connection method

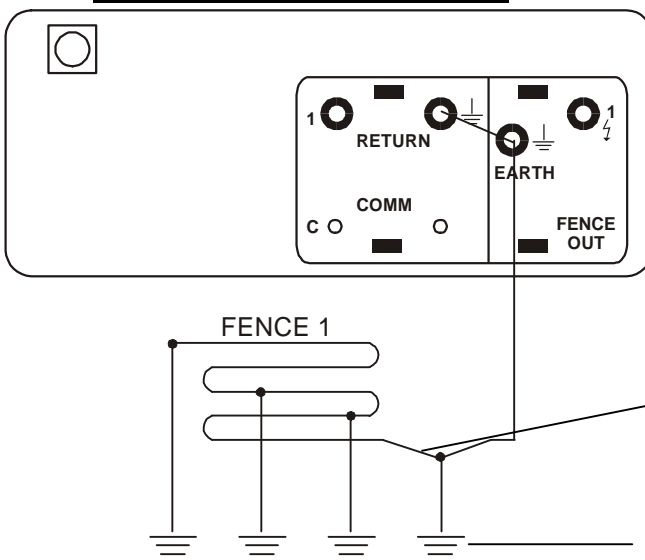

Fence earth wire to be connected from the main earth spike, NOT straight from the energizer

Main earth spike – install close to the energizer

LIVE WIRE CONNECTION

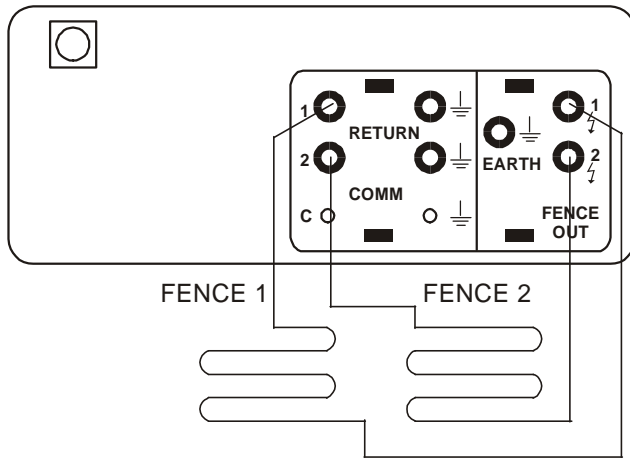

NOTE:
The installation and erection of the electric fence to be done in South Africa according to SANS 10222-3 latest edition. In other countries according to the local specifications.

EARTH WIRE CONNECTION WITH EARTH LOOP MONITORING

Preferred connection method

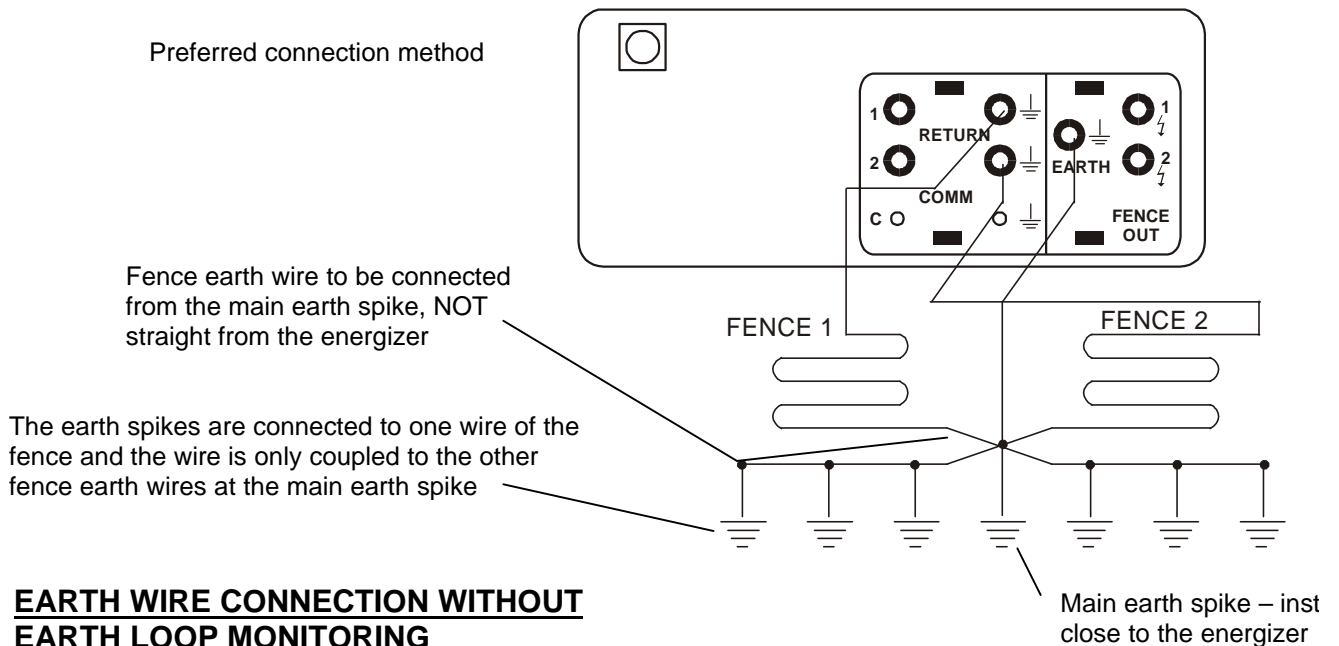

EARTH WIRE CONNECTION WITHOUT EARTH LOOP MONITORING

Alternative connection method

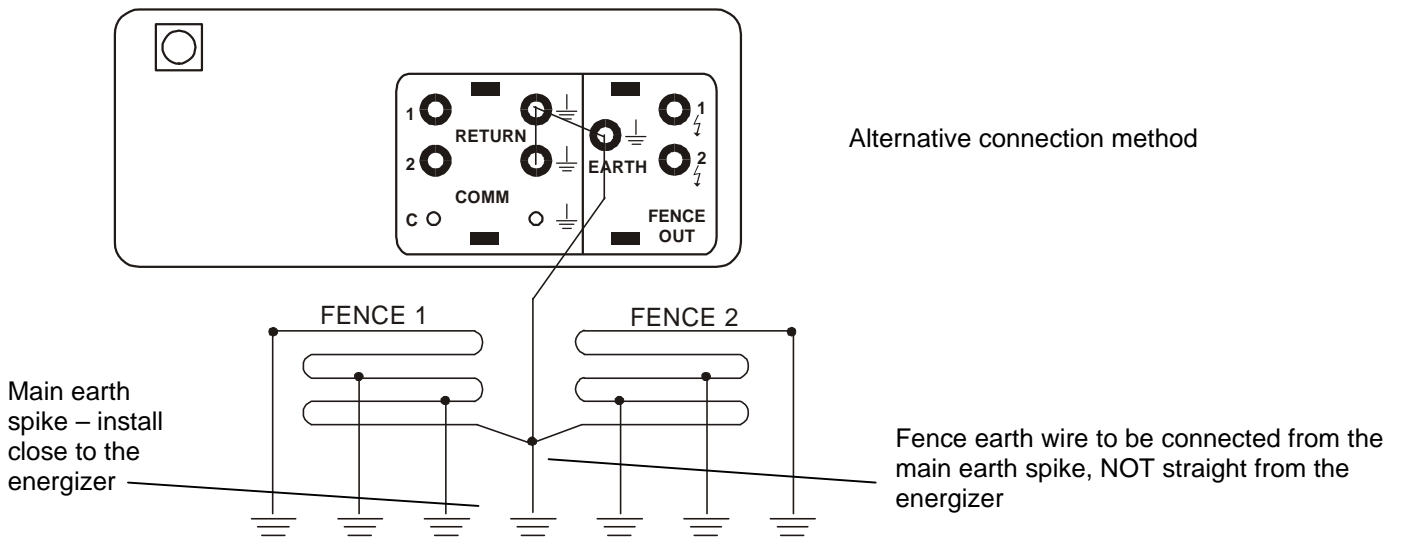

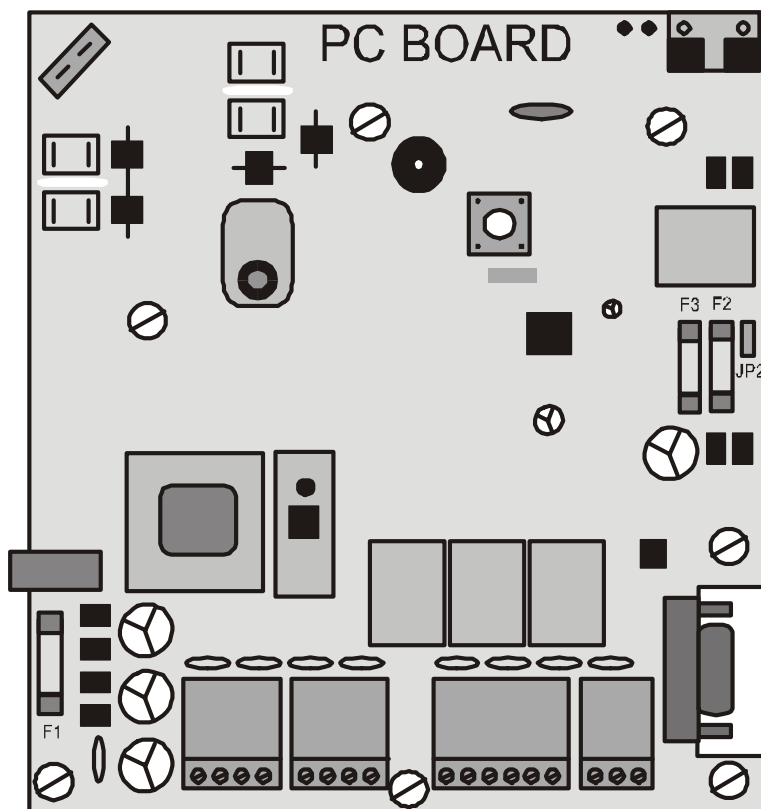
FUSE DESCRIPTION & FAULT SYMPTOMS**F1 CHARGER FUSE (4A FAST BLOW)**

If blown the power LED will be off while Mains is present. When the battery goes flat a service alarm will be given and unit will stop operating. Check Mains supply before replacing.

F2 AUXILARY SUPPLY FUSE (2A FAST BLOW)

If blown the Keypad will be off, Siren and Strobe light will not operate. Check Siren, Strobe and Keypad as well as their wiring before replacing.

F3 BATTERY FUSE (2A FAST BLOW)

If blown the unit will switch off immediately when Mains fails. Check Battery and Battery Leads before replacing.

MERLIN STEALTH

PC Board Replacement Procedures

REMOVAL:

STEP 1: Disconnect mains and battery terminals if connected

STEP 2: Remove screws

STEP 3: Remove all connectors from PC Board

STEP 4: Gently pull PC Board straight up to remove (connections on the back)

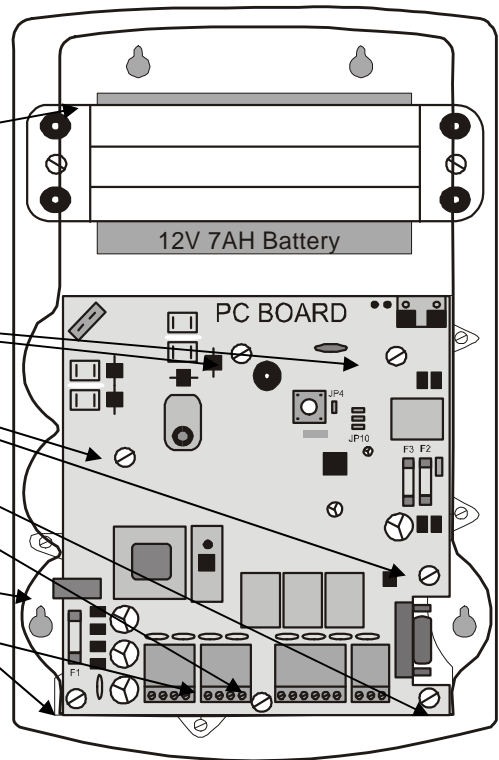

REPLACEMENT:

STEP 5: Gently push PC Board back into place

Take care that the spade connectors are correctly positioned before pushing the PC Board into place.

Also ensure that the opto-couplers (look like LED's) are correctly positioned before pushing the PC Board into place

STEP 6: Insert and tighten all screws

STEP 7: Reconnect all connectors to PC Board

STEP 8: Reconnect battery terminals

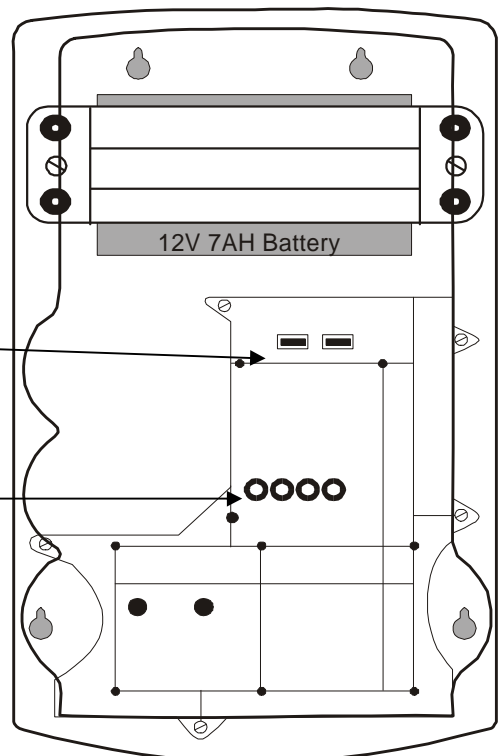

INSTALLATION NOTES:

1. Keep the wires to the fence separate from the keypad/gate/siren/strobe/mains/remote wiring.
2. Do **not try and modify the unit**. Any unauthorised modifications will null and void the warranty and possibly render the unit illegal.
3. If the **remote On/Off** facility is used, the wire between the remote switch and the energizer can be up to a 100m. For security reasons it is better to use an intelligent FOB on the keypad bus.
4. A **remote receiver** can obtain **12VDC** from the keypad bus. Current consumption must not exceed 1 Amps. This **is not sufficient to supply power** for an armed response transmitter.
5. The **siren** and **strobe light** together must not draw more than 1.75Amps.
6. To connect a **radio alarm transmitter** or **alarm panel** to the energizer use an isolation relay between the strobe light output and the panel. Never use the energizer battery to power a radio alarm transmitter or alarm panel.
7. The wire between the **magnetic gate switch** and the energizer can be up to a 100m but must not run in parallel with the fence wires. The gate switch must be open circuit if the gate is open.
8. The **remote keypad cable** must not exceed a 100m in total. **Avoid running this cable in parallel with any fence (high voltage) wires.**
9. You can connect a total of four keypads or FOB units to one energizer. Each must have a unique address setting.
10. Use **high voltage insulation wire** between the fence and energizer, including the earth wire. Never run these wires in the same conduit or through the same hole as the low voltage wiring.
11. Always use ferrules or line clamps to connect two **high voltage wires** together. Avoid using different types of material for connections like copper on steel.
12. The **fence** must be **earthed** properly with at least one earth electrode as close as possible to the energizer. The distance between the fence earth electrode and other earth systems shall be not less than 10 m.
13. When **replacing** the **lid** of the energizer hook the top in first while holding it an angle and then push it closed at the bottom. Fasten the lid down with the two cap screws.
14. Always **test** the **fence** alarm for a short and open-circuit after installation at the furthest point on the fence.

15. Do not use the energizer with **Non-rechargeable** batteries and any lead-acid batteries must be placed in a well-ventilated area during charging.
16. The unit contains a sealed lead-acid battery that will vent to the atmosphere under certain conditions. For this reason it is imperative that the **energizer be installed in a well ventilated area.**
17. Refer to the applicable laws concerning the installation of electric fences.
18. If mains power is not available to power the energizer the unit may be powered by removing the internal battery and connecting an external battery to the battery leads. Jumper 2, JP2 (next to Fuse 2) must be inserted to bypass the battery disconnect relay. Failure to do so will result in the unit not powering up. In order to prevent damage to the unit, the correct polarity must be observed and the battery voltage must remain below 14 Volts.
19. **Ensure that the bare wire of the HT cables connected to the energizer terminals do not extend beyond the terminals. This may cause arcing at the terminals which could result in strange behaviour including the energizer turning off. Make sure the terminals are fastened properly.**
20. When working on the energizer with the front cover removed, do not touch the plastic component located under the magnetic switch label on the front cover. The internal switch is made from glass and breaks easily.

BASIC DEFINITIONS:

Electric Fence: a barrier which includes one or more electric conductors, insulated from earth, to which electric pulses are applied by an energizer

Connecting Lead: an electric conductor, used to connect the energizer to the electric fence or the earth electrode

Electric Security Fence: a fence used for security purposes which comprises an electric fence and a physical barrier electrically isolated from the electric fence.

Public Access Area: any area where persons are protected from inadvertent contact with pulsed conductors by a physical barrier.

Pulsed Conductors: conductors which are subjected to high voltage pulses by the energizer.

Secure Area: an area where a person is not separated from pulse conductors below 1,5m by a physical barrier.

GENERAL REQUIREMENTS FOR ELECTRIC SECURITY FENCES:

Electric fences shall be installed and operated so that they cause no electrical hazard to persons, animals or their surroundings.

Electric fence constructions which are likely to lead to the entanglement of animals or persons shall be avoided.

An electric fence shall not be supplied from two different energizers or from independent fence circuits of the same energizer.

For any two different electric fences, each supplied from a different energizer independently timed, the distance between the wires of the two electric fences shall be at least 2.5m. If this gap is to be closed, this shall be effected by means of electrically non-conductive material or an isolated metal barrier.

Barbed wire or razor wire shall not be electrified by an energizer.

Any part of an electric fence which is installed along a public road or pathway shall be identified at frequent intervals by prominently placed warning signs securely fastened to the fence posts or firmly clamped to the fence wires. The size of the warning signs shall be at least 100mm x 200mm. The background colour of both sides of the warning plate shall be yellow. The inscription on the plate shall be black. The warning sign shall typically appear as depicted in Figure below. The inscription shall be indelible, inscribed on both sides of the warning plate and have a height of at least 25 mm.

Warning signs shall be placed at

- each gate
- each access point

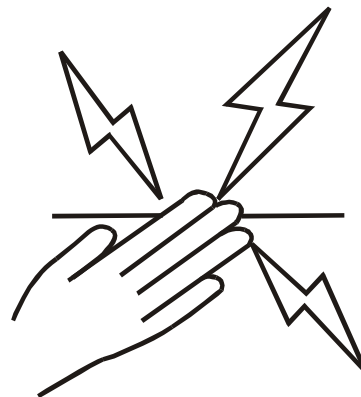

- intervals not exceeding 10m
- adjacent to each sign relating to chemical hazards for the information of emergency services.

Gates in electric security fences shall be capable of being opened without the person receiving an electric shock.

The energizer earth electrode shall penetrate the ground to a depth of at least 1m. The distance between any electric security fence earth electrode and other earth systems shall not be less than 2m.

Connecting leads that are run inside buildings shall be effectively insulated from the earthed structural parts of the building. This may be achieved by using insulated high voltage cable.

Connecting leads that are run underground shall be run in a conduit of insulating material or else insulated high voltage cable shall be used. Care shall be taken to avoid damage to the connecting leads due to external factors.

Connecting leads shall not be installed in the same conduit as the mains supply wiring, communication cables or data cables.

Connecting leads and electric fence wires shall not cross above overhead power or communication lines.

Mains supply wiring shall not be installed in the same conduit as signalling leads associated with the electric security fence installation.

Crossings with overhead power lines shall be avoided wherever possible. If such a crossing cannot be avoided, it shall be made underneath the power line and as nearly as possible at right angles to it.

If connecting leads and electric fence wires are installed near an overhead power line, the clearances shall not be less than those shown in Table 1.

Power Line Voltage (V)	Clearance(m)
Equal or less than 1 000	3
>1 000 and equal or less than 33 000	4
>33 000	8

Table 1

If connecting leads and electric fence wires are installed near an overhead power line, their height above the ground shall not exceed 3m.

Where an electric security fence passes below bare power line conductors, the highest metallic element shall be effectively earthed for a distance of not less than 5m on either side of the crossing point.

This height applies either side of the orthogonal projection of the outermost conductors of the power line on the ground surface, for a distance of

- 2m for power lines operating at a nominal voltage not exceeding 1 000 V
- 15m for power lines operating at a nominal voltage exceeding 1 000V

Electric security fences and their ancillary equipment shall be installed, operated and maintained in a manner that minimizes danger to persons, and reduces the risk of persons receiving an electric shock unless they attempt to penetrate the physical barrier, or are in a secure area without authority. Exposed conductive parts of the physical barrier shall be effectively earthed.

A spacing of 2.5 m shall be maintained between un-insulated electric fence conductors or un-insulated connecting leads supplied from different energizers. This spacing may be less where conductors or connecting leads are covered by insulating sleeving, or consist of insulated cables, rated to at least 10kV.

This requirement need not apply where the separately energized conductors are separated by a physical barrier, which does not have any openings greater than 50mm.

A vertical separation of not less than 2.5m shall be maintained between pulsed conductors fed from different energizers.

Ensure that all ancillary equipment connected to the electric security fence circuit provides a degree of isolation between the fence circuit and the supply mains equivalent to that provided by the energizer. Protection from the weather shall be provided from the ancillary equipment unless this equipment is certified by the manufacturer as being suitable for use outdoors, and is of a type with a minimum degree of protection IPX4.

DOCUMENT REVISION HISTORY

Revision 1.0

19 September 2005

Revision 1.1

24 November 2005

Warning about safety switch added

Default energy reduced in HV mode for safety reasons during manufacturing.

Alarm threshold voltage made adjustable in HV mode.

Revision 1.2

29 November 2005

Wiring schematics added.

Revision 1.3

3 October 2006

Installation notes 18 and 19 added.

Revision 1.4

5 February 2007

Table of contents updated

High and Low Power typical readings added

Magnetic switch function added

Distance between wires of different fences changed to 2.5m

Revision 1.5

23 February 2007

Warning Head contact with fence added

Lid Alarm function added

Remote On/Off absolute or transition sensitive added

High Power Fence Voltage default changed to 0 (auto)

End of document